

**Catalogue d'illustrations  
pour personnaliser  
votre calendrier 2027**

Sélectionner les numéros des illustrations à insérer sur vos calendriers (10 maximum)



3 formats au choix :

Format 70 x 50 cm (recto seul)

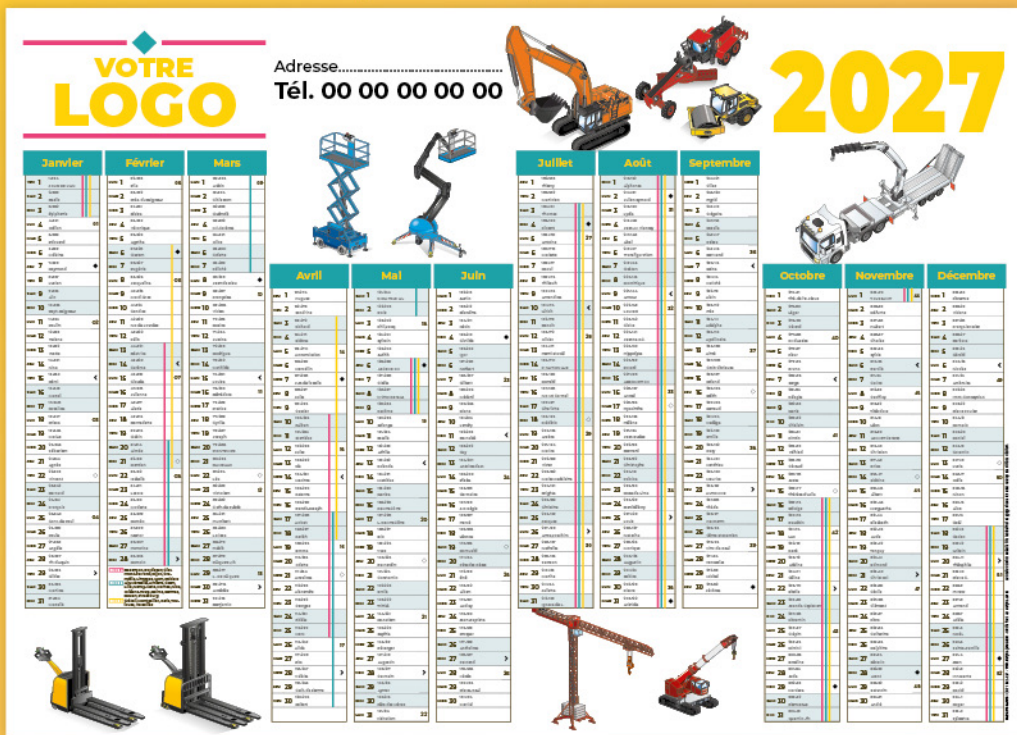

Format A3 (recto seul)



Format A4 (recto-verso)



# CARISTE

01



02



03



04



05



06



07



08



09



10



11



# GERBEUR

# TRANSPALETTE

12

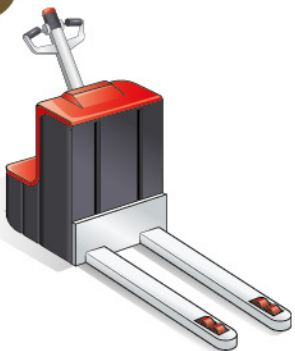

13



14

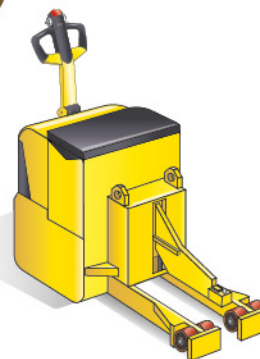

15



16



17

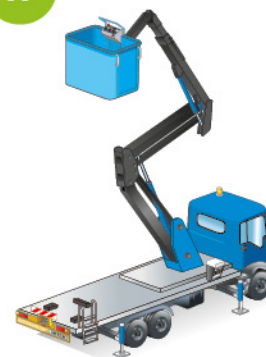

18



19



20



# PEMP

# ENGIN DE CHANTIER

21



22



23

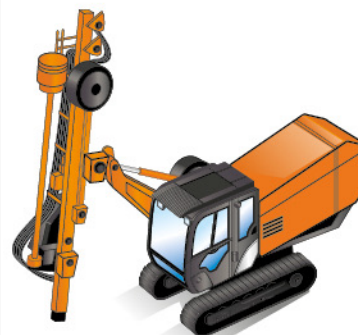

24



25



26



27



28



29



30



31



## GRUE DE CHARGEMENT

32



33



34



35



36

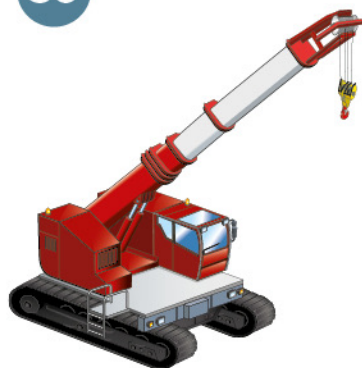

37



38



39



40



## GRUE À TOUR

AIPR

41

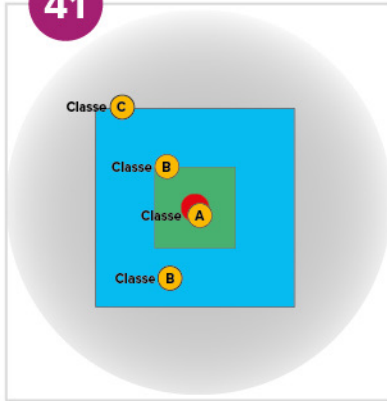

42



43



44

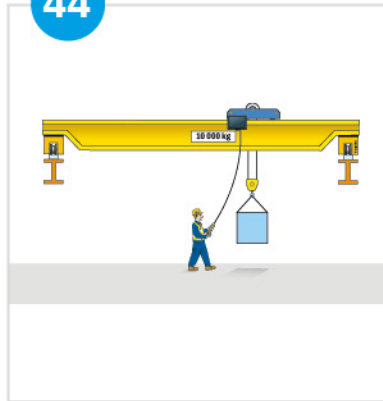

45

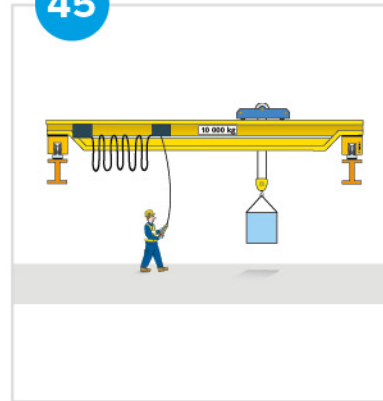

46

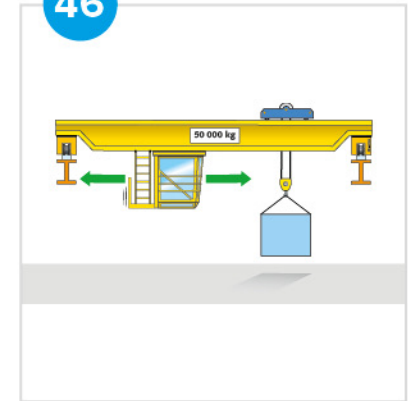

47

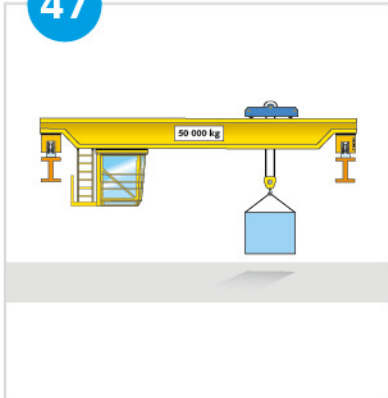

48

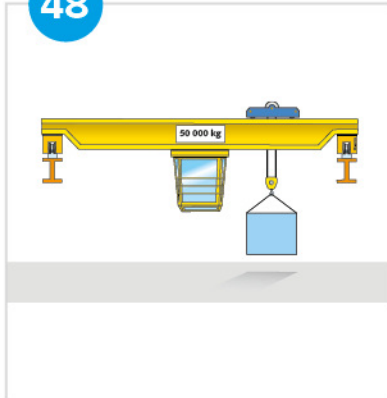

49

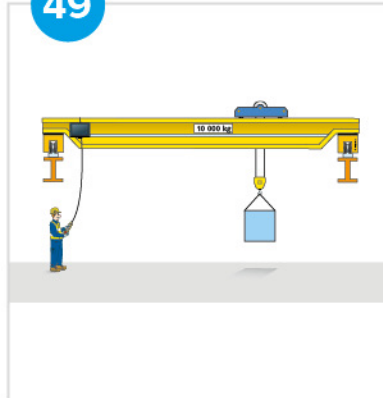

50

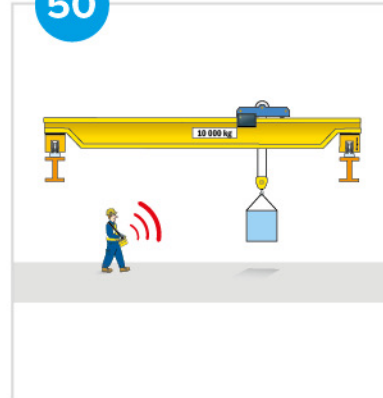

PONT  
ROULANT

# HABILITATION ÉLECTRIQUE

51



52



53



54

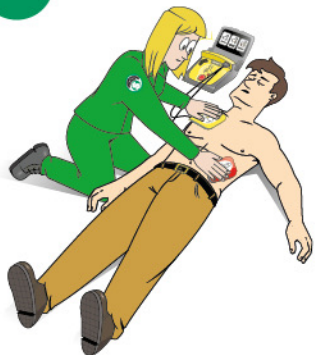

55



56



57



# GESTES ET POSTURES

# RISQUE CHIMIQUE

58



59

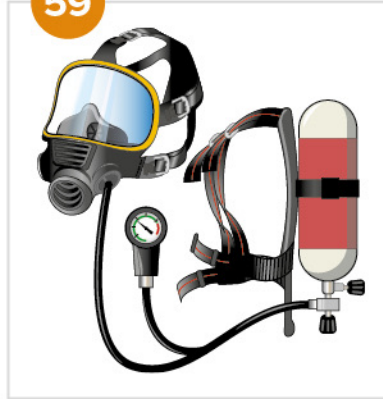

60



61

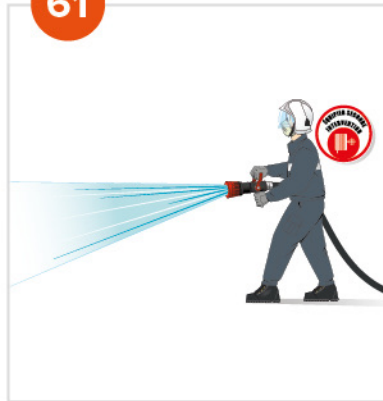

62



63



64



65



66



67



68



## ESPACE CONFINÉ



## TRAVAIL EN HAUTEUR

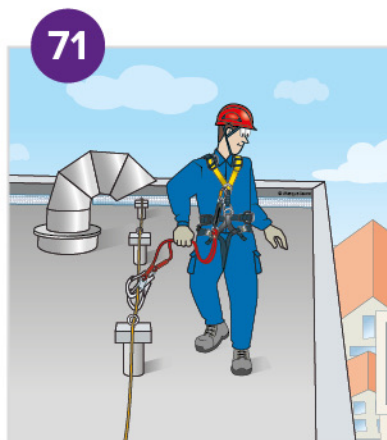
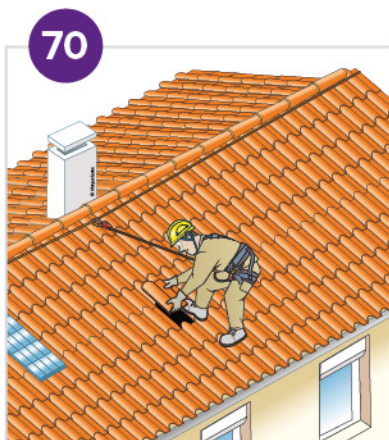

## ÉCHAFAUDAGE DE PIED, ROULANT

# Renseignez les emplacements de vos illustrations sur le bon de commande

Formats 70 x 50 cm et A3

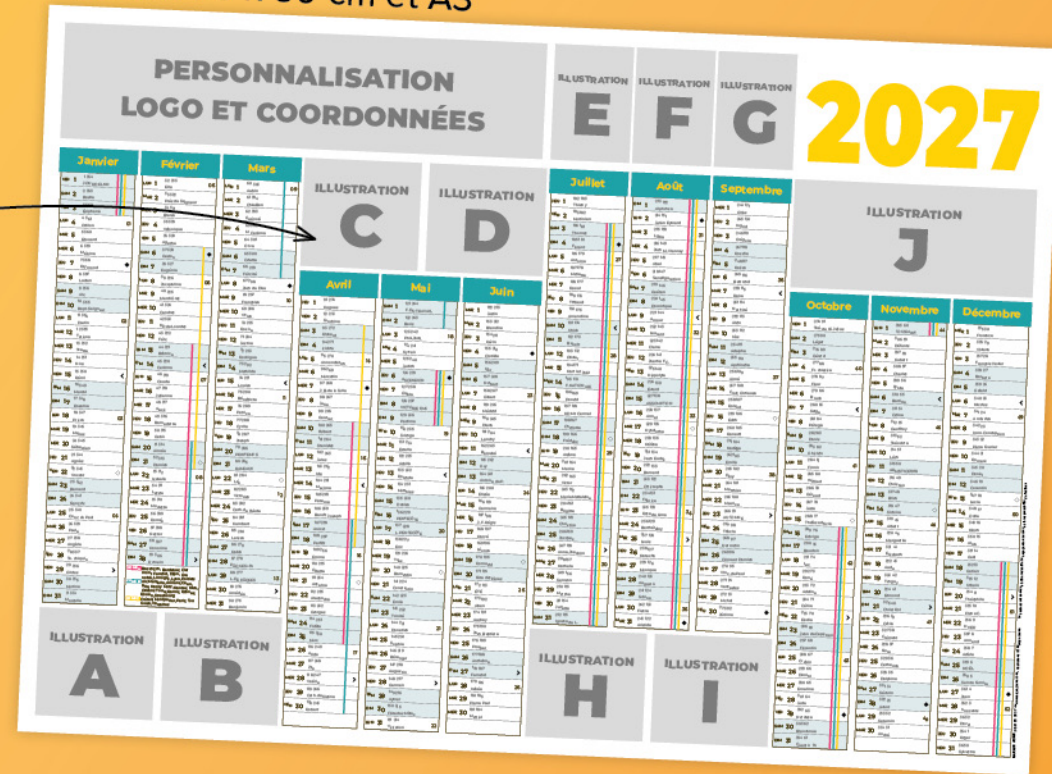

## CHOIX ILLUSTRATIONS

- |                                      |                            |
|--------------------------------------|----------------------------|
| <b>A</b> ILLUSTRATION : n° <u>32</u> | <b>F</b> ILLUSTRATION : n° |
| <b>B</b> ILLUSTRATION : n° <u>33</u> | <b>G</b> ILLUSTRATION : n° |
| <b>C</b> ILLUSTRATION : n° <u>38</u> | <b>H</b> ILLUSTRATION : n° |
| <b>D</b> ILLUSTRATION : n° <u>40</u> | <b>I</b> ILLUSTRATION : n° |
| <b>E</b> ILLUSTRATION : n°           | <b>J</b> ILLUSTRATION : n° |

Format A4



Cliquez  
pour télécharger le

**Bon de commande**

# Mémo Forma.fr

Édition santé et sécurité au travail



Quelques  
exemples  
de créations...



Cliquez  
pour télécharger le

**Bon de commande**